



SERVING THE FOOD INDUSTRY SINCE 1951

Worktop Refrigerator With Backsplash

ITEM: 50095 50097 50099 50100
 MODEL: RE-CN-0006-BS-HC RE-CN-0011-BS-HC RE-CN-0015-BS-HC RE-CN-0016-BS-HC



Upgrade your kitchen's efficiency with our Worktop Refrigerator With Backsplash.

Our Worktop Refrigerator with Backsplash combines reliable cooling with a durable prep surface. Featuring even air distribution, adjustable controls, sturdy shelves, and self-closing doors, it offers smart storage and efficient performance.

- Stainless Steel Interior & Exterior
- Self Closing Glass Doors
- Automatic Defrost System
- Adjustable heavy duty PVC coated shelves
- Digital Temperature Control
- Eco Friendly R290 Refrigerant

Telephone: 1-800-465-0234

Fax: (905) 607-0234

Email: sales@omcan.com

Website: www.omcan.com

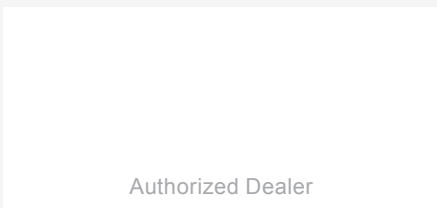

Authorized Dealer

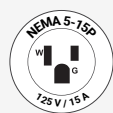

Made in China

Updated:
September 16, 2025 9:07 AM js

TECHNICAL SPECIFICATION				
Features	5 cu.ft/ 154 L 27" - 1 door	11 cu.ft./ 320 L 47" - 2 doors	15 cu.ft / 425 L 60"- 2 doors	17 cu.ft./ 481 L 72"- 3 Doors
Item	50095	50097	50099	50100
Model	RE-CN-0006-BS-HC	RE-CN-0011-BS-HC	RE-CN-0015-BS-HC	RE-CN-0016-BS-HC
Capacity	5 cu.ft/ 154 L	11 cu.ft./ 320 L	15 cu.ft / 425 L	17 cu.ft./ 481 L
Power	210 W	270 W	345 W	290 W
Current	1.8 A	2.4 A	4.5 A	2.7 A
Number of Doors	1 Self Closing Door	2 Self Closing Doors		3 Self Closing Doors
Number of Shelves	1	2	2	3
Shelf Capacity	88 lbs / 40 kgs			
Electrical	110-120V / 60Hz / 1Ph			
Refrigerant	R290			
Shelf Material	Plastic Coated			
Cooling System	Ventilated			
Temperature Controller	Digital			
Insulation Material	Cyclopentane			
Defrosting	Automatic			
Temperature Range	0.5 to 5°C / 33 to 41°F			
Casters	Yes			
Plug Type	NEMA 5-15P			
Interior Dimensions (WDH)	22.4" x 19.84" x 23.5" / 569 x 504 x 597 mm	42.6" x 19.8" x 23.5" / 1083 x 504 x 597 mm	55.6" x 19.8" x 23.5" / 1413 x 504 x 597 mm	66.9" x 19.8" x 23.5" / 1698 x 504 x 597 mm
Net Weight	158.7 lbs / 72 kgs	213.8 lbs / 97 kgs	253.5 lbs / 115 kgs	297.6 lbs / 135 kgs
Net Dimensions (WDH)	27" x 29.5" x 38.8" / 685 x 750 x 985 mm	47.2" x 29.5" x 38.8" / 1200 x 750 x 985 mm	60.2" x 29.5" x 38.8" / 1529 x 750 x 985 mm	72" x 29.5" x 38.8" / 1829 x 750 x 985 mm
Gross Weight	202.8 lbs / 92 kgs	275.6 lbs / 125 kgs	324.1 lbs / 147 kgs	372.6 lbs / 169 kgs
Gross Dimensions (WDH)	29.7" x 32.3" x 38.2" / 755 x 820 x 970 mm	50" x 32.3" x 38.2" / 1270 x 820 x 970 mm	63" x 32.3" x 38.2" / 1600 x 820 x 970 mm	74.2" x 32.3" x 38.2" / 1885 x 820 x 970 mm

TECHNICAL DRAWING

Item: 50095

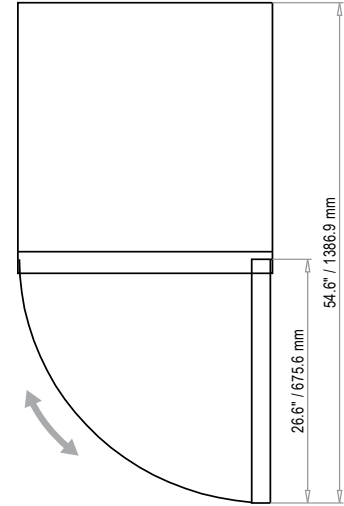
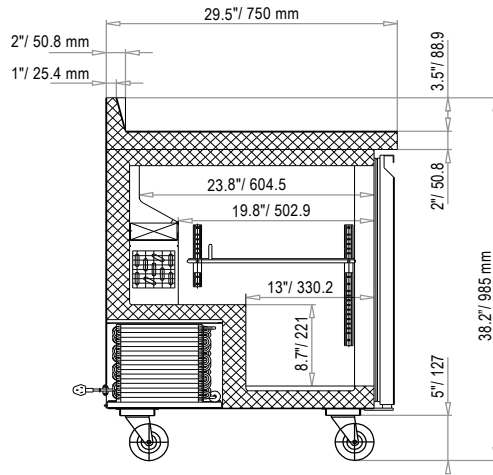
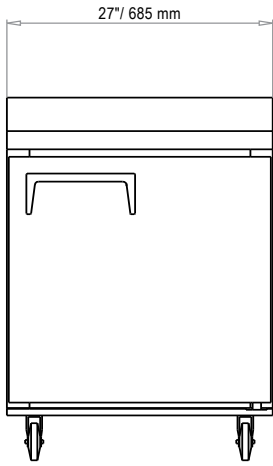

Item: 50097

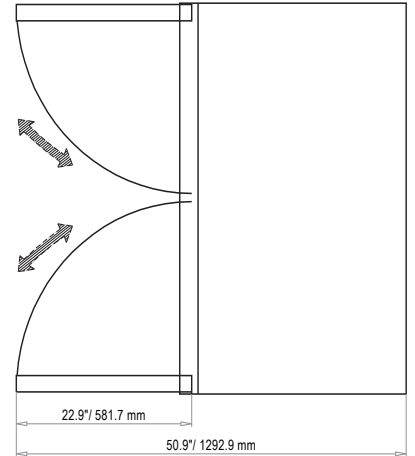
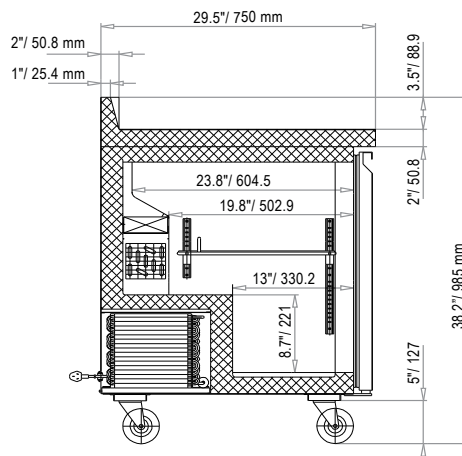
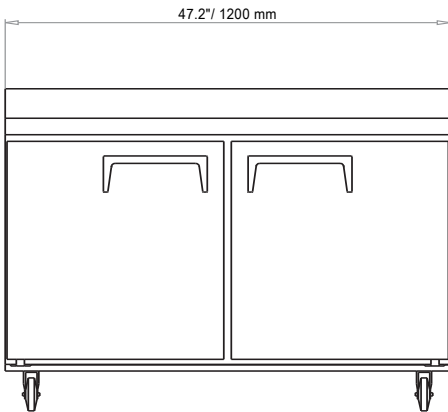

TECHNICAL DRAWING

Item: 50099

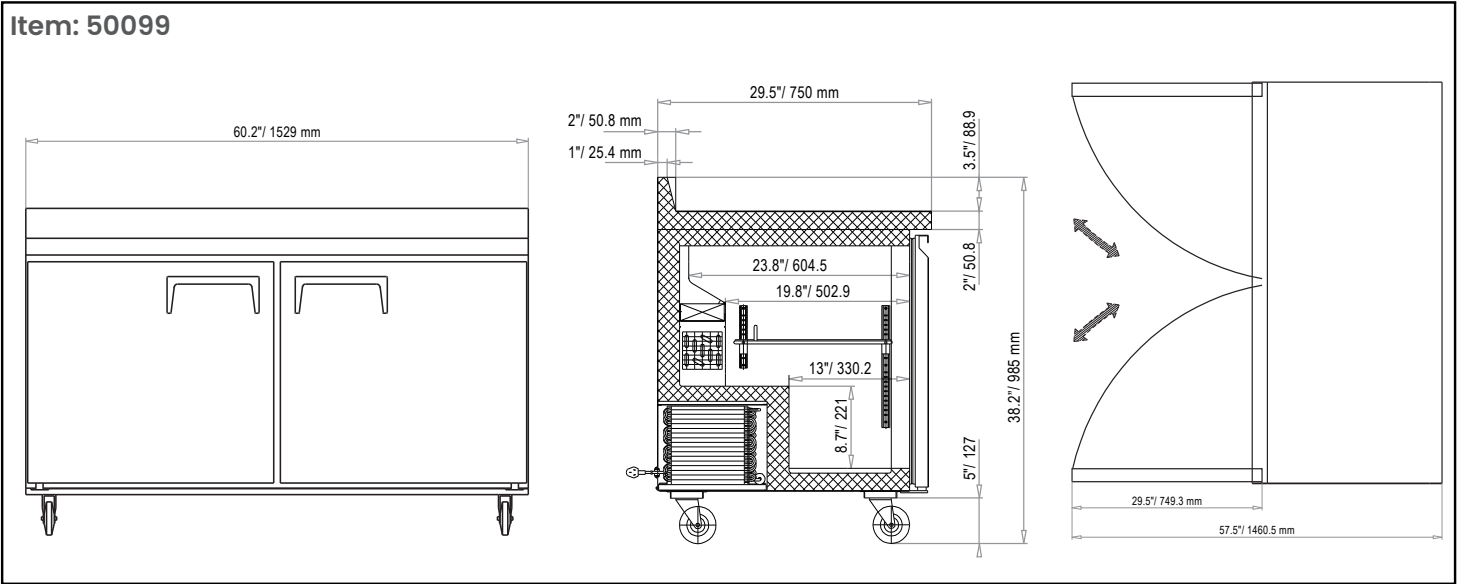

Item: 50100

