



COMPETITOR SERIES®

PROJECT: _____
 LOCATION: _____
 ITEM#: _____
 QUANTITY: _____



C-U27F-HC



C-U36F-HC



C-U48F-HC



C-U60F-HC

UNDER-COUNTER/WORK TOP FREEZERS

- Beautiful ergonomic construction & rounded corners
- Digital temperature controller and read-out
- All stainless steel exterior and interior
- Forced air refrigeration system
- Recessed door handles
- Pre-installed casters and shelving
- 90 degree hold open door feature for loading products
- Optional Accessory: Backsplash for Work-Tops for in-the-field installation**, Taller 6" casters available***
- All Natural R290 Hydrocarbon Refrigerant
- US Department of Energy Certified
- Migali® Protection Plan: 2 Year Parts & Labor Warranty, 5 Years Compressor Warranty

MODEL	DOORS	CAPACITY CU/FT	SHELVES	H/P	AMPS	VOLTAGE	ENERGY CONSUMPTION KWH/24 HR	PLUG TYPE	TEMP RANGE	EXTERIOR DIMENSIONS W X D X H*	INTERIOR DIMENSIONS W X D X H	PACKAGED DIMENSIONS W X D X H	WEIGHT	PACKAGED WEIGHT
C-U27F-HC	1	6.5	2	1/5	1.8	115/60/1	2.7	Nema 5-15P	-7° F (~) 3° F	27.5 x 30 x 34.1	23.9 x 23.6 x 26.7	29 x 32 x 39	146 lbs.	179 lbs.
C-U36F-HC	2	8.7	2	1/4	2.6	115/60/1	3.21	Nema 5-15P	-7° F (~) +3° F	36.3 x 30 x 35.2	32.6 x 23.6 x 26.7	38.5 x 32.3 x 38.2	172 lbs.	222 lbs.
C-U48F-HC	2	12	4	1/4+	2.6	115/60/1	4.1	Nema 5-15P	-7° F (~) 3° F	48.25 x 30 x 34.1	44.7 x 23.6 x 26.7	50 x 32 x 39	203 lbs.	245 lbs.
C-U60F-HC	2	17.9	4	1/4+	2.6	115/60/1	4.9	Nema 5-15P	-7° F (~) 3° F	60.25 x 30 x 34.1	56.7 x 23.6 x 26.7	63 x 32 x 39	230 lbs.	276 lbs.

* Total height includes casters

**Accessories: Stainless Steel Back Splash - BS27 - 27" wide / BS48 - 48" wide / BS60 - 60" wide

*** Optional 6" casters available - Part # 1759-208

FOR COMMERCIAL USE ONLY

NOTE: MIGALI® RESERVES THE RIGHT TO CHANGE SPECIFICATIONS WITHOUT NOTICE



TOLL FREE: 800.852.5292
 WEB: www.migali.com



DIMENSIONAL DRAWINGS

C-U27F-HC

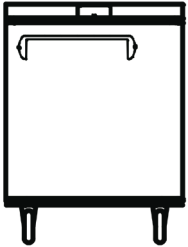

C-U36F-HC

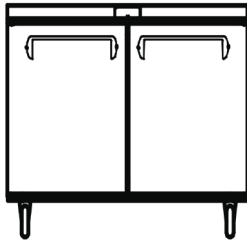

C-U48F-HC

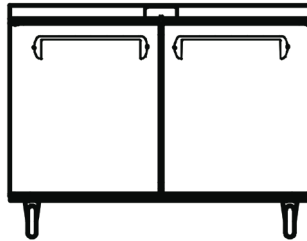

C-U60F-HC

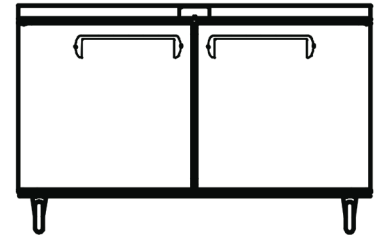

C-U27R-HC
TOP VIEW

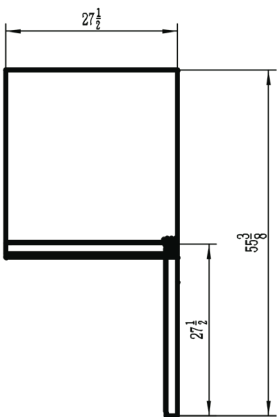

C-U36R-HC
TOP VIEW

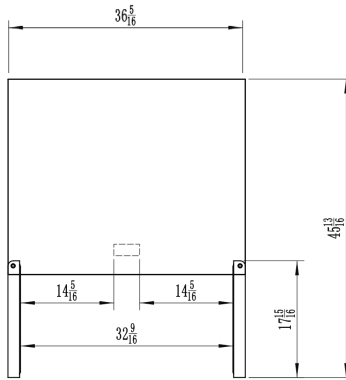

C-U48R-HC
TOP VIEW

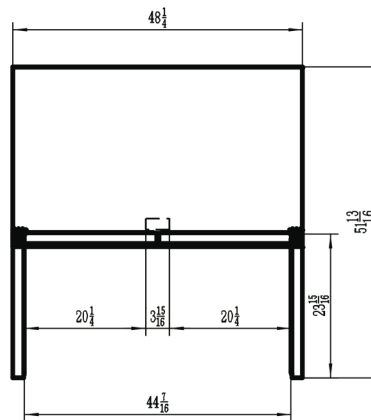

C-U60R-HC
TOP VIEW

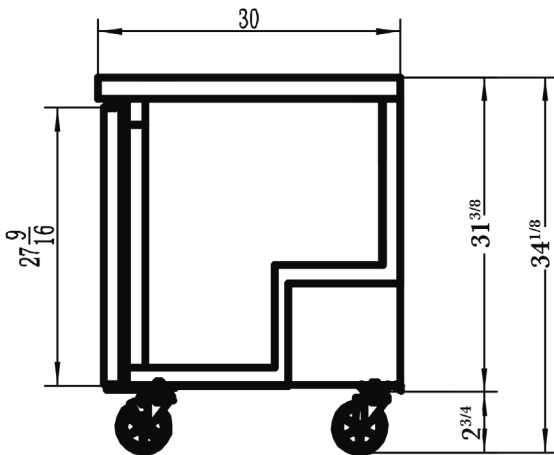
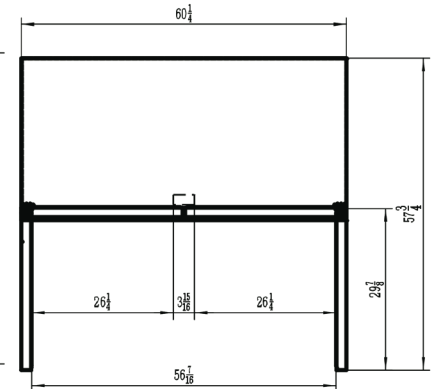

SIDE VIEW (1,2,3) DOOR MODELS



MIGALI® REMAINS AN AMERICAN FAMILY COMPANY SINCE 1955